

Retinal Neurotransmitters

Robert E. Marc

John Moran Eye Center
University of Utah School of Medicine
Salt Lake City UT

Number of Text Words: 8359
Number of Figures: 0
Number of Tables: 6
Number of References: 85

Abbreviated Title: **Retinal Neurotransmitters**

*Correspondence to: Robert E. Marc, Moran Eye Center, University of Utah, 75 North
Medical Dr., Salt Lake City UT 84132.
Phone: (801) 585-6500.
Facsimile (801) 581-3357
robert.marc@hsc.utah.edu

Introduction

Fast synaptic signaling in the vertebrate retina encodes presynaptic voltages as time-varying modulations in extracellular neurotransmitter concentrations that are decoded by postsynaptic transmembrane ionotropic or heptahelical receptor arrays. Additional heptahelical receptor pathways conditionally modulate synaptic signaling, often on lower temporal and spatial frequency scales. The six major retinal neurotransmitters glutamate, γ -aminobutyrate (GABA), glycine, acetylcholine, dopamine, and serotonin are formed by group transfer reactions and associated with specific cellular sources and targets in precise connective patterns. The sources and targets of less circumscribed small molecule modulators are mentioned but briefly and peptides are treated elsewhere. Vertical channels deploy fast, high-gain glutamatergic synapses between photoreceptors (PRs) and their bipolar (BC) and horizontal cell (HC) targets, and between BCs and their amacrine (AC) and ganglion cell (GC) targets. Lateral channels composed of HCs and ACs primarily use fast, low-gain sign inverting GABAergic and glycinergic synapses, with specialized circuits employing high-gain sign conserving cholinergic signaling. Four modes of fast synaptic transfer dominate neuronal receptive field circuits: high-gain, sign conserving (\rightarrow) or inverting ($i\rightarrow$), and low-gain, sign conserving (\Rightarrow) or inverting ($i\Rightarrow$). The following sections summarize metabolic networks, transporters, receptors, and circuitries for each neurotransmitter species, concluding with a précis of future directions. Tables 1-6 encapsulate metabolic network diagrams, Enzyme (EC) and Transport Commission (TC) codes, localizations of macromolecules associated with a neurotransmitter phenotype and other data. References are restricted to reviews or recent exemplars of concepts from which original literature may be traced.

The Vertical Channel Neurotransmitter: L-Glutamate (Table 1)

Glutamate Metabolic Networks. L-glutamate is a net anion at physiological pH and the central amino acid in a vast network of group transfers in all cells. No enzyme exclusively controls intracellular glutamate levels and no enzyme cluster defines a glutamatergic phenotype. Cellular contents of glutamate and other small molecules reflect group transfer, energetic, redox, osmoregulatory and signaling demands that require supramillimolar concentrations ≈ 10 - $100\times$ greater than required to charge tRNAs for protein synthesis. Many transport epithelia and other somatic cells maintain 1-10 mM glutamate, levels as high as PRs, BCs and GCs: neurons are not unique in this regard. Neuronal glutamate is predominantly derived from glutamine produced in Müller cells (MC), but the retinal pigmented epithelium (RPE) maintains 2-10 mM glutamine and could be a source for PRs. Normal MCs display avid glutamate transport but contain little glutamate (50-500 μ M) due to robust conversion by glutamine synthetase (glutamate-ammonia ligase, Table 1). Glial glutamine export appears driven by trans-activated System N (SN1) transporters (Chaudhry et al., 1999) and neuronal glutamine import by the Na⁺-dependent Glt1 transporter (Varoqui et al., 2000). Glutaminase on the inner mitochondrial membrane exterior deamidates glutamine to glutamate within intermembrane space, from whence glutamate may be transported to the mitochondrial matrix to drive 2-oxoglutarate synthesis or escape to the cytosol via porin channels.

Glutamate Transporters. Vesicular glutamate import is mediated by VGluT1 and VGluT2 transporters, members of the Na⁺-dependent plasma membrane PO₄⁻ symporter family (e.g. Takamori et al., 2000). VGluT1 is strongly expressed in both the outer and inner plexiform layers (Stobrawa et al., 2001) and VGluT2 has yet to be mapped, though it is differentially distributed in brain (Varoqui et al., 2002). Anionic glutamate import ($K_m \approx 1$ -3 mM) is strongly coupled to $\Delta\Psi$ generated by vATPase proton accumulation. The number of VGluTs per vesicle, their transfer numbers and resultant vesicular glutamate concentrations are all undetermined. Electron microscopic immunocytochemical data in lamprey spinal cord estimate vesicular glutamate levels at ≈ 60 mM), but true levels could be up to ten-fold lower.

Plasma membrane high-affinity glutamate transporters ($K_m \approx 5$ -50 μ M) are single 10 transmembrane domain (TMD), one re-entrant loop (RL) polypeptides and members of the widely distributed Na⁺-dependent acidic and neutral amino acid transporter superfamily (Seal and Amara, 1999). Import is coupled to the sodium gradient (ΔpNa) and $\Delta\Psi$ (increased transport at negative potentials) and experimental collapse of these gradients activates transporter export sufficient to empty a neuron of glutamate in minutes. Physiologically, export is gradually activated by increasingly positive potentials, although the net import/export balance is not known. Import is weakly electrogenic due to Na⁺/H⁺ symport but can be

strongly electrogenic by activating non-stoichiometric Cl⁻ channel conductance increases ($\uparrow g_{Cl}$). Four glutamate transporters are expressed in the mammalian retina: predominantly EAAT1 in MCs; EAAT2 in cones and BCs; EAAT3 in HCs, ACs and GCs; EAAT5, in non-mammalian MCs and mammalian rods (Pow et al., 2000).

Plasma membrane glutamate transporters likely shape synaptic kinetics, control glutamate overflow and recycle carbon skeletons. HC response kinetics are shaped by cone glutamate transporters (Gaal et al., 1998; Vandenbranden et al., 1996) and EAAT2 should act similarly at BC \rightarrow AC and BC \rightarrow GC synapses. The relative roles of intrasynaptic neuronal and extrasynaptic glial transport are unresolved. Neuronal transport may couple intrasynaptic glutamate levels to cone voltage via transporter $\Delta\Psi$ dependence (Gaal et al., 1998) when Ca²⁺ flux through voltage-independent cone inner segment cation channels drives vesicle fusion at potentials below Ca²⁺ channel activation (Rieke and Schwartz, 1994).

EAATs on BC dendrites could have novel receptor-like activity by activating $\uparrow g_{Cl}$ but ON-center BC responses are abolished in mGluR6 knockout mice (Masu et al., 1995) and all BC responses can be blocked with glutamate receptor-specific agents. EAAT-like involvement in PR $i \rightarrow$ ON-center BC signaling is more compelling in fishes where hyperpolarizations arise from glutamate-activated $\uparrow g_{Cl}$ (Grant and Dowling, 1996).

Ionotropic Glutamate Receptors (iGluRs). Vertebrate iGluRs are a diverse group (Dingledine et al., 1999), decoding glutamate signals as cation currents via ionotropic AMPA and KA receptors: apparently non-ordered tetramers of 3 TMD-1 RL subunits with mid-to-high micromolar glutamate thresholds, separable pharmacologies and transient channel opening properties. AMPA receptor GluR1-4 subunits are produced by a single gene family, with a large number of alternatively spliced and RNA edited forms, while KA receptor GluR5-7 and KA1,2 subunits arise from two gene families, also with post-translational modifications. The orphan receptor subunits $\delta 1,2$ are yet another family of likely iGluR subunits. This diversity potentially yields iGluR assemblies with varied unitary conductances, ionic selectivities, kinetics and affinities, as well as protein kinase A and C (PKA, PKC) modulation, and post-synaptic aggregation control through specialized domains. Receptor diversity is further enhanced by mixed iGluR expression (e.g. Ghosh et al., 2001) and the coexistence of different functional AMPA assemblies in one cell (Zhang et al., 1995). AMPA and KA receptors tend to activate brief conductances in the 1-20 pS range, though some KA receptors can activate larger conductances, while AMPA receptors containing GluR2(R) subunits have substantially smaller unitary conductances.

Functional NMDA receptors are obligate heteromeric 3TMD-1RL tetramers or pentamers of NR1 and NR2 subunits, requiring concurrent glutamate and glycine binding and depolarization relief of uncompetitive Mg⁺⁺ channel block, and gating unitary conductances 2-3 \times larger than AMPA/KA receptors that activate/deactivate more slowly, with less desensitization than AMPA/KA receptor currents, and are more glutamate-sensitive. Co-activated with AMPA receptors in retina (Diamond and Copenhagen, 1995), functional NMDA-activated pathways appear restricted to AC and GC subsets (Fletcher et al., 2000; Marc, 1999).

Heptahelical Glutamate Receptors. Heptahelical glutamate receptors are GPCR Group C members requiring homodimer formation for signaling. The only heptahelical receptor that completely regulates a synaptic pathway is the mGluR Group III mGluR6 localized to ON-center BC dendrites (Vardi et al., 2000a). How mGluR6 activation effects closure of ON-center BC cation channels is unknown and as all mammalian ON-center BCs express a single isoform of mGluR6, any filtering differences must arise within or after in the G-protein signaling path, where G α_o appears to be the coupler (Dhingra et al., 2000). ON-center BCs in tetrapods, but perhaps not fishes, appear to be under the complete control of mGluR6 signaling.

Other mGluRs have been localized to the retina, but specific pathway functions have not been delineated. Group I-like systems generally mediate intracellular Ca⁺² modulations and isoforms of both mGluR1 and 5 have been localized to the inner retina (Koulen et al., 1997b). Group II mGluR2 isoforms may inhibit synaptic release and the most distinctive, but likely not exclusive, localization is the expression of mGluR2 by starburst ACs (Koulen et al., 1996). Group III mGluRs 4,7,8 are widely expressed in the inner retina but their functional roles await analysis.

Glutamatergic Signal Processing. AMPA receptors dominate physiological PR → HC signaling, (Blanco and de la Villa, 1999) even though HCs may co-express AMPA GluR2,3,4 (Haverkamp et al., 2001; Morigiwa and Vardi, 1999) and KA GluR6,7 receptors (Brändstatter et al., 1997). Cone → OFF BC signaling in mammals is decoded by KA receptors in two classes of OFF-center BCs and AMPA receptors in a third (DeVries, 2000), generating fast AMPA-driven and slower KA-driven BC classes, perhaps initiating transient and sustained OFF channels, analogous to ON-center BC shaping of transient and sustained ON channels described by Awatramani and Slaughter (2000). OFF-center BCs of non-mammals may be dominated by AMPA receptors. Signaling via mGluR6 appears as the sole process controlling mammalian ON-center BCs. Mammalian rod BCs have been shown to express GluR2 AMPA subunits, but their role is yet unknown

BC → AC and GC signaling in all vertebrates is dominated by AMPA receptors (Marc, 1999), though KA receptors may shape some responses. ACs and GCs display cell-specific responses to glutamate agonists and responsiveness fractionation suggests that physiological attributes such as “sluggish” or “brisk” responses may be determined in part by different AMPA receptor assemblies (Marc and Jones, 2002). NMDA receptor expression varies across ACs and GCs and both immunocytochemical and physiological mappings reveal that specific inner plexiform layer strata driven by cone BCs are enriched with AC and GC dendrites bearing NMDA receptors (Fletcher et al., 2000; Marc, 1999) while rod BC sublayer AC targets lack NMDA receptors (Ghosh et al., 2001; Marc, 1999).

Glutamate: Future Directions. Is there a macromolecular signature for a glutamatergic neuron phenotype? VGluT is currently the sole identifier of a glutamatergic phenotype (Eiden, 2000), but other gene products such as EAAT2 may be coordinately regulated with VGluT and transcription factor clusters may ultimately define the glutamatergic phenotype. Detailed spatial mapping and biophysics will be required to resolve the contributions of glial and neuronal EAAT transporters to synaptic kinetics. The mGluR6 transduction pathway and its target channel remains a major puzzle. Do adapter proteins modify its properties and does receptor oligomerization influence signaling? What are the consequences of expressing mixed AMPA, KA, and δ receptors. Do mGluRs shape specific networks or are they diffuse, subtle adaptive elements? Why are NMDA receptors relegated to subsets of ACs and GCs and absent from rod BC targets?

The Dominant Lateral Channel Fast Inhibitory Neurotransmitter: GABA (Table 2)

GABA Metabolic Networks. GABA, an achiral zwitterionic non-protein amino acid, evolved into a signal from its ancestral metabolic role. Vertebrate GABA synthesis from glutamate is driven by two glutamic acid decarboxylases (GAD1/GAD67 and GAD2/GAD65, Table 2), differing in targeting and regulation. GABA catabolism is aerobic, largely driven by mitochondrial matrix GABA transaminase serial oxidation of GABA to succinate semialdehyde and succinate, driving the citrate cycle (Kalloniatis and Tomisich, 1999). Most GAD-containing retinal neurons are likely GABAergic, although some somatic tissues synthesize GAD and GABA, and developing glutamatergic motor neurons in *Drosophila* require GAD expression (Featherstone et al., 2000). Supramillimolar GABA content remains a strong marker of GABAergic function and neuronal GABA signals span the inner plexiform layer in all species.

Subsets of HCs and ACs have been shown to express GABA signals, GABA transport and GAD content (reviewed by Marc, 1992). Most ACs are GABA⁺ and GAD⁺, though a complete match has yet to be achieved. GABA signal strengths vary widely across AC classes (\approx 1-10+ mM), forming characteristic quantitative GABAergic signatures. All cholinergic, serotonergic and many peptidergic ACs are GABAergic and are thus multi-neurotransmitter neurons. Interplexiform cells are AC variants whose processes target the outer retina and several IPC classes may contain GABA (Marc, 1995).

Vertebrate HCs remain neurochemically recalcitrant despite a long history of physiological analysis. GABA content, GABA transport and GAD are expressed by subsets of HCs in many species, but many HCs express no known neurotransmitter signature. A neurotransmitter-free model of feedback signaling via connexin currents has been proposed by Kamermans et al. (2001) though not all problems are thereby solved. Why do any HCs contain GABA if they use connexins for feedback? Some non-mammalian HCs form conventional synapses onto glycinergic interplexiform cells (IPCs) and other tar-

gets in fishes (reviewed in Marc, 1992; Marc, 1995), but may use connexin signaling for cone feedback. Mammalian HCs are equally challenging. Rodent HCs are GABA⁻ but express GABA in development; macular primate HCs are GABA⁺ but become GABA⁻ in the periphery; rabbit type B HCs are all GABA⁻ while type A HCs are GABA⁺ in the streak and GABA⁻ in the periphery. All rabbit HCs are GAD67 immunoreactive at their dendritic tips, suggesting fine regulation of signaling (Johnson and Vardi, 1998). All feline, canine and porcine HCs express GABA (Kalloniatis and Tomisich, 1999; Marc, 1992).

Many species display weak GABA signals in small subsets of the BC cohort and some have been shown to contain GAD. Some may acquire GABA through heterocellular coupling while others may be true sign inverting elements. The ganglion cell layer in many species contains many GABA⁺ cells, mostly displaced starburst ACs, while the remainder are GCs coupled to GABAergic ACs (Marc and Jones, 2002).

GABA Transporters. The vesicular transporter VGAT is a 10 TMD polypeptide related to the plant amino acid permease family, is 2-3 fold selective for GABA ($K_m \approx 5$ mM) over glycine (McIntire et al., 1997) and widely distributed in the inner plexiform layer and in mammalian HCs (Haverkamp et al., 2000).

Most non-mammalians express only neuronal AC and HC GABA transport while mammals express neuronal AC and glial MC transport. Three mammalian, single polypeptide 12 TMD, Na⁺-coupled GABA transporters (GAT1,2,3) are present in the mammalian retina (Johnson et al., 1996), though GAT2 is more closely related to the epithelial osmoregulatory GABA/betaine transporter and is expressed in the RPE, which contains no detectable GABA. GAT1 is widely expressed in some but not all GABAergic ACs, while MCs preferentially display GAT3. No HC has been found to express these proteins, even those with robust GABA transport.

GATs may regulate of synaptic kinetics they are localized on presynaptic GABAergic neurons and neuronal transporter blockade can dramatically slow IPSP kinetics (Cherubini and Conti, 2001). GAT3-mediated GABA transport by MCs is avid in mammals, buffering any additional synaptic overflow, though non-mammalians do not to require glial support.

Is GABA export a surrogate for or adjunct to vesicular GABAergic synaptic transmission (O'Malley et al., 1992; Schwartz, 1999; Yazulla, 1995)? GABA import is ΔpNa and $\Delta\Psi$ -coupled, with greater import at negative potentials. Collapse of ΔpNa or decreasing $\Delta\Psi$ activates ligand export, but is it physiologically significant? Isolated fish HCs can export physiologically detectable GABA *in vitro* upon depolarization (Schwartz, 1999), suggesting transport can mediate feedback or feedforward. However, neither GABA transport nor GATs have been detected in mammalian HCs and reconciliation of these observations awaits new work.

Ionotropic GABA Receptors. GABA_A and GABA_C receptors, members of the ligand-gated channel superfamily, are partially ordered pentameric assemblies of 4 TMD α (1-6), 2 β (1-3), γ (1-4), δ , ϵ , θ , and π subunits, some with splice variants. Co-assembly of 2 α and 2 β subunits, at least, is required to form functional surface-expressed GABA_A receptors (Connor et al., 1998). GABA_A receptors gate large, rapidly desensitizing $\uparrow gCl$ with GABA thresholds in the 10 μ M range. GABA_C receptors are homomeric assemblies of ρ (1-3) subunits, are more GABA sensitive and activate weaker but relatively non-desensitizing $\uparrow gCl$. Cones, BCs and GCs are known to concurrently express functional GABA_A and GABA_C receptors (Feigenspan and Bormann, 1994; Picaud et al., 1998; Zhang et al., 1997b).

Heptahelical GABA Receptors. Functional GABA_B receptors (Group C GPCRs) are R1-R2 isoform heterodimers (Jones et al., 1998; Sullivan et al., 2000). R1a and R1b versions have been mapped to HCs, ACs and GCs (Koulen et al., 1998; Zhang et al., 1998a) and physiological data have shown GCs and BCs to bear functional, pharmacologically defined GABA_B receptors, in some cases exhibiting complex switching behavior (Zhang et al., 1998b). GPCR coupling of GABA_B receptors can activate $\uparrow gK$, hyperpolarizing target neurons, whereas others gate increases in $[Ca^{2+}]_i$ (Zhang et al., 1997b) or inhibit presynaptic Ca^{2+} currents (Matthews et al., 1994).

GABAergic Signal Processing. GABAergic signaling is primarily inhibitory, effected through ionotropic hyperpolarizations/shunts or GPCR pathways. The HC \Rightarrow cone GABAergic pathway has been

difficult to validate due to its varied expression. HC \Rightarrow cone feedback in amphibians clearly involves ionotropic GABA receptors (Wu, 1994) and most of the components of the pathway are expressed in most vertebrates. Unconventional feedback mechanisms such as connexin-based feedback currents and $\Delta\Psi$ -coupled GABA transporter export enrich signaling possibilities but do not reduce uncertainty. Mammalian HCs lack GABA transport while the presence of VGAT provokes the idea that vesicular transmission can occur from HC dendrites. Mammalian HCs display presynaptic vesicle clusters within photoreceptor synaptic terminals but are documented infrequently (e.g. Linberg and Fisher, 1988).

The HC to BC path has argued from anatomical data but the relative HC- and AC-driven surround strengths remain unclear. BCs express dendritic GABA_A and GABA_C receptors (Greferath et al., 1994; Haverkamp et al., 2000; Koulen et al., 1997a) consistent with GABAergic HC \Rightarrow OFF BC signaling through $\uparrow gC$, forming a proper surround polarity. GABAergic HC \Rightarrow ON BC signaling through $\uparrow gCl$ must be *sign conserving* for proper surround polarity and specialized chloride importers likely shift ON-center BC dendritic E_{Cl} to positive levels to achieve polarity reversal, while preserving a proper negative E_{Cl} at the axon terminal (Vardi et al., 2000b).

AC \Rightarrow BC signaling is supported by abundant evidence in all vertebrates. How GABA_A and GABA_C receptors differentially shape BC responses is just now emerging. GABA-sensitive, slower GABA_C receptors may initiate feedback control at low contrasts, with less sensitive, faster GABA_A receptors dominating at high contrast. The involvements of GABA_B receptors appear complex and may vary over BC types. GABAergic AC \Rightarrow AC signaling numerically dominates retinal circuitry, is largely GABA_A mediated (Lukasiewicz and Shields, 1998) with concatenated inhibitory chains enriching network assembly (Marc and Liu, 2000). All GCs show significant GABAergic inputs, much of it driven by receptors with GABA_A-like pharmacologies (Akopian et al., 1998), though some clearly use concurrent GABA_A / GABA_B / GABA_C signaling (Zhang et al., 1997b).

GABA: Future directions. Diverse data support GABAergic signaling by some HCs, but inconsistencies persist and many HCs lack detectable GABA. How do these cells function? Where are the synapses and GABA transporters in mammalian HCs? The mysteries involving AC \rightarrow BC, AC, GC signaling events are more straightforward. We need to understand the functional consequences GABA receptor types and subtype mixtures. What are the contributions of glial and neuronal GATs to synaptic kinetics and do ACs use GABA export to supplant or augment vesicular release?

3 The Minor Lateral Channel Fast Inhibitory Neurotransmitter: Glycine (Table 3)

Glycine Metabolic Networks. Glycine is an achiral zwitterion at physiological pH with limited conformers. Glycine content is elevated in specific ACs with sparse, varicose dendrites: e.g. mammalian AII and DAPI-3 ACs. Lower levels are found in mammalian ON-center BCs that acquire glycine by coupling leakage from AII ACs. ACs with high glycine levels may also contain low GABA levels in many species, perhaps from heterocellular coupling. Retinal glycine synthesis is still unresolved. The glycine hydroxymethyltransferase is reportedly elevated in retina and spinal cord and converts precursor serine to glycine, glycinergic ACs contain no significant precursor serine (Kalloniatis and Tomisich, 1999). Of course many GABAergic ACs contain little glutamate, so precursors are not proven indices of phenotype. Conversely, somatic cells also use alanine-glyoxylate transferase to produce glycine and precursor L-alanine is elevated in retina and perhaps in glycinergic ACs. Glycine transport has been proposed as a novel mechanism for elevating AC glycine levels based on the depletion of AC glycine by sarcosine (methylglycine), a glycine transport agonist (Pow, 1998), though this effect may have been complicated by trans-activated glycine export.

Glycine Transporters. No glycine-selective vesicular transporter has been identified and the nominal inhibitory amino acid vesicle transporter VIAAT transports GABA and glycine with similar efficacy, while VGAT is only 2-3 fold selective for GABA over glycine. Either might serve a neuron with elevated levels of glycine and no GABA.

Plasma membrane AC glycine transport is mediated by GlyT1, a member of the sodium-coupled solute symporter family and the signature macromolecule of the retinal glycinergic phenotype. As with EAATs and GATs, collapse of $\Delta\Psi$ or ΔpNa can evoke complete glycine export in minutes but under normal conditions GlyT1 likely regulates synaptic kinetics.

Ionotropic Glycine Receptors. Glycinergic signaling is mediated exclusively by ionotropic glycine receptors (GlyRs), apparently non-ordered multimers of α 1-4 and β subunits. Subunit α 1 is abundant in the mammalian inner plexiform layer and is expressed on BCs and GCs (Wässle et al., 1998), though ACs with well-documented anatomical glycinergic inputs must certainly express GlyR as well. Glycine activates large, rapidly desensitizing $\uparrow gCl$, especially in GCs. Since glycine activates gCl in parallel with GABA_A and GABA_C receptors, often on adjacent synapses (Marc and Liu, 2000), glycinergic signaling may avoid inhibitory *occlusion*: subadditivity due to GABA spillover at adjacent synapses.

Glycinergic Signal Processing. The best-known mammalian glycinergic circuit is the rod $i \rightarrow$ rod BC \rightarrow AII AC $i \rightarrow$ cone OFF BC pathway, where OFF BC GlyRs render the pathway net sign conserving, as is appropriate for OFF-center channels. This arcane evolutionary capture of cone pathways to serve scotopic signaling is absent in advanced non-mammalian retinas expressing complete, separable rod and cone ON and OFF pathways to GCs. Most GCs receive glycinergic input and the distributions of GlyRs on identified GCs match relative GABAergic and glycinergic presynaptic process densities in specific inner plexiform layer strata. Though their processes are sparse, glycinergic ACs are potent and mediate complex behavior via local and wide-field systems, intercalating in sign inverting chains with GABAergic ACs ((Cook et al., 2000; Marc and Liu, 2000; Zhang et al., 1997a).

The glycinergic IPC of non-mammals is best characterized in teleosts (Marc, 1995). It is pre-synaptic and postsynaptic in both plexiform layers and part of its role may be to transfer H1 signals from the outer to the inner plexiform layer, bypassing the BCs spatial filter.

Glycine: Future Directions. The vesicle transporter of glycinergic ACs and the mechanism that elevates glycine content remain unknown. Does glycine transport shape synaptic kinetics in the retina? Does glycinergic transmission prevent synaptic occlusion? Why are glycinergic ACs of mammals and non-mammals structurally similar but involved in such different networks?

The Lateral Channel Fast Excitatory Neurotransmitter: Acetylcholine (Table 4)

Acetylcholine Metabolic Networks. Acetylcholine is a small quaternary cation synthesized by cholineacetyl transferase (ChAT), a cholinergic phenotype signature macromolecule. Attempts to localize retinal acetylcholine by immunocytochemistry have not succeeded. Conversely, [³H] choline uptake autoradiography and ChAT immunocytochemistry label the same ACs. Extracellular retinal acetylcholinesterase (AChE) terminates synaptic acetylcholine signaling.

Acetylcholine and Choline Transporters. Acetylcholine is transported into AC vesicles by VAChTs (Koulen, 1997), a member of the toxin-extruding proton-translocating antiporter family, and under coordinate regulation with ChAT expression. The ligands for these transporters are cations, so proton antiport and ΔpH dominates vesicle loading.

Synaptic or overflow acetylcholine is cleared by AChE with transfer rate of $\approx 10^4$, effecting rapid hydrolysis of acetylcholine into choline and acetate. Choline is a significant agonist at some acetylcholine receptors and Na^+ -coupled choline transport via ChT1 may be essential to prevent adventitious receptor desensitization as well for choline recovery.

Ionotropic Acetylcholine Receptors. Ionotropic cholinergic transmission is mediated by nicotinic acetylcholine receptors (nAChRs), ordered pentameric assemblies of 4 TMD α , β , and γ subunits. Nine neuronal α subunits are known, imparting distinctive properties to channels: e.g. $\alpha 7$ subunits are thought to form homomers with high Ca^{2+} permeability and are expressed widely in the inner plexiform layer. The $\beta 2$ subunit is also abundant in ACs and GCs (Keyser et al., 2000) and $\alpha 3\beta 2$ assemblies are apparently involved in developmental excitatory periodicity linked to retinothalamic patterning (Bansal et al., 2000).

Heptahelical Acetylcholine Receptors. The muscarinic acetylcholine receptors (mAChRs) are Group A GPCRs. Subtypes M₂, M₃ and M₄ have been immunolocalized in avian retinas and are expressed by GCs, ACs and BCs (Fischer et al., 1998). Cholinergic starburst ACs express type M₂ receptors consistent with autoreceptor regulation of acetylcholine release.

Cholinergic Signal Processing. Every vertebrate displays displaced ON and conventional OFF cholinergic starburst AC homologues and bistratification of cholinergic signatures in the inner plexiform layer. Non-mammals express two or three additional cholinergic ACs, though the functions of the additional cells are unknown. All cholinergic ACs are also GABAergic, confounding simple circuitry analysis. Only starburst AC circuits have been properly analyzed (Famiglietti, 1991) and they are driven by cone BCs through a high-sensitivity AMPA receptor (Marc, 1999), primarily targeting GCs. Though few starburst AC > AC contacts have been validated, unclassified GABAergic ACs may be excited by starburst ACs through nAChRs (Dimitrieva et al., 2001), perhaps amplifying GC surround inhibition GCs in dim photopic conditions. Any direct signaling between starburst ACs is likely GABAergic and sign inverting, since starburst AC receptive fields are small. Starburst ACs drive directionally selective (DS) GCs in the rabbit retina through nAChRs, but are not needed for directional selectivity *per se* (He and Masland, 1997; Kittila and Massey, 1997).

Acetylcholine: Future Directions. Understanding cholinergic function requires more physiological data in light-driven preparations, discrimination of cholinergic and GABAergic synapses, and pharmacologic dissection of nAChRs and mAChRs. Though starburst ACs can be driven to release GABA by export (O'Malley et al., 1992), they lack the neuronal GABA transporter GAT-1 (Dimitrieva et al., 2001): which do they use? Does ChT1 play any role in signal termination?

The Global Modulator: Dopamine (Table 5)

Dopamine Metabolic Networks. Dopaminergic retinal neurons are ACs or IPCs (reviewed by Witkovsky and Deary, 1991) that express tyrosine 3-mono-oxygenase (tyrosine hydroxylase, TH) and lack conversion of dopamine to norepinephrine and epinephrine. Their sparse processes facilitate global signaling and dopamine is not spatially buffered, effectively reaching sites tens of microns from the inner plexiform layer (Witkovsky et al., 1993). Tyrosine is an essential amino acid acquired exogenously and accumulated through TAT1 aromatic amino acid transport. In dopaminergic neurons it is converted to DOPA by TH and DOPA to dopamine by aromatic L-amino acid decarboxylase. Aromatic amines are highly oxidizable and rapid turnover is common in aminergic neurons. Mitochondrial monoamine oxidase converts dopamine to DOPAL, a highly toxic intermediate, then converted to the acetate form for export, apparently by diffusion. As TH is the first stage in tyrosine conversion to neuroactive monoamines, it is present in rare additional neurons that may synthesize neorepinephrine or epinephrine, though little is known of their dispositions and roles.

Dopamine Transporters. Dopamine is loaded into synaptic vesicles by VMAT2, the neuronal form of the vesicle amine transporter family ((Erickson and Varoqui, 2000). As with other cationic amines, loading is strongly coupled to Δ pH.

The 12 TMD dopamine transporter DAT is similar to most other Na⁺-coupled transporters and is susceptible to trans-activation of dopamine export via transporter agonists such as amphetamines. Its involvement in spatial buffering is somewhat unclear since diffusing dopamine is a potent signal. However, dopaminergic neurons form many synapse-like contacts and highly targeted axonal fields, suggesting that specific connective zones are under higher regulation than others.

Heptahelical Dopamine Receptors. All known dopamine receptors are heptahelical Group A (rhodopsin-like) GPCRs coupled through G_s (subtypes D1, D5) or G_{i/o} (D2, D3, D4), and grouped as pharmacological D1/D2 adenylyl cyclase activating/suppressing cohorts, respectively. No retinal cell, including MCs and the RPE, lacks some form of dopamine receptor, and many express both D1/D2 pharmacologies.

Dopaminergic Signal Processing. Dopaminergic neurons apparently signal the onset of photopic epochs through vesicular and dopaminergic effects emerge in seconds to minutes, rather than milliseconds. In teleosts, dopamine activates cone contraction, uncouples HCs and renders GCs more transient through D1 mechanisms, mimicking light adaptation (Vaquero et al., 2001; Witkovsky and Dearry, 1991). Coupling control between HCs in teleosts is effected by the axonal fields of dopaminergic IPCs, while that between mammalian AII ACs is effected by axonal fields of dopaminergic ACs in the distal inner plexiform layer (Hampson et al., 1992). In amphibians, dopamine shifts the balance of PR → HC signaling in favor of cones, in part by reducing rod I_h currents via D2 receptors (Akopian and Witkovsky, 1996). The actual patterning and control of dopamine release remains uncertain, but dopaminergic ACs/IPC appear to be under massive GABA_A receptor-gated suppression and relief from inhibition uncovers spontaneous DA release, perhaps generated by constitutive repetitive spiking ((Feigenspan et al., 1998). But many dopaminergic neurons also receive explicit BC inputs and express iGluRs, so the situation is far from clear. Mammalian, reptilian and avian dopaminergic ACs have also been reported to contain GABA, complicating interpretations further.

Dopamine: Future Directions. A tremendous amount of analysis of dopamine receptor pharmacology has already been done, but how those signaling pathways are themselves regulated and how adaptation state controls and is controlled by dopaminergic neurons demands further exploration.

The mystery neurotransmitter: Serotonin

Serotonin Metabolic Networks. Serotonin is present at high levels in specific non-mammalian AC subsets. The mammalian retina contains at most 10-fold less serotonin than dopamine, much of that attributable to platelets and photoreceptor synthesis of melatonin. In the CNS, the phenotype-defining enzyme tryptophan hydroxylase (TrpH) converts TAT1-imported tryptophan to 5-hydroxytryptophan, but thereafter the same enzymes expressed in all other aminergic neurons control serotonin production. There is yet no evidence that any mammalian AC expresses TrpH.

Serotonin Transporters. As for dopaminergic neurons in brain, VMAT2 is the obligatory vesicle transporter, though its intraretinal distribution is yet unknown. The content of VMAT2-expressing vesicles thus tracks the substrate amine content of cytosol and VMAT2 expression is not a phenotype signature. All known and suspected serotonergic ACs are also GABAergic neurons, perhaps expressing both VMAT2 and VGAT.

High-affinity serotonin transport is mediated by SERT, a classic Na⁺-coupled single polypeptide, 12 TMD transporter susceptible to inhibition by numerous agents such as fluoxetine. In many vertebrates, more neurons express serotonin transport (PRs, BC subsets, AC subsets) than are immunoreactive for serotonin, including the the GABAergic mammalian A17/S1/S2: No satisfactory explanation has emerged: some of these cells may truly express SERT while others (e.g. some BCs) may have a coupling leak with a *bona fide* serotonergic AC.

Ionotropic Serotonin Receptors. The 5HT3 serotonin receptor is an assembly of unknown stoichiometry of presumed 4 TMD subunits. 5HT3A and B variants have been described and both must apparently be expressed to mimic conductances and pharmacologic profiles of native 5HT3 receptors (Davies et al., 1999). 5HT3A subunits have been localized to mammalian rods, suggesting potential pre-synaptic control of rod signaling by endogenous serotonin of unknown provenance (Pootanakit and Brunken, 2001).

Heptahelical Serotonin Receptors. The GCPR Group A serotonin receptors comprise a complex array of response element receptors, with 15 subtypes in seven families. Among this cohort, 5HT2A receptors are known to be expressed on PRs and rod BCs in the mammalian retina (Pootanakit et al., 1999). Some controversy exists whether phospholipase C coupling is activated through Gq or Gi signaling, but the potential for generating IP3 or diacylglycerol signals near the membrane raises the possibility that serotonin could activate transient receptor potential (TRP) non-selective cation channels, some of which (TRP7) are expressed in retina.

Serotonergic Signal Processing. Little is known of the functions of serotonin in the retina, due to the pharmacologic complexities of serotonin receptors, the fact that many GPCRs have constitutive activity and that many agents act as inverse agonists, capable of generating effects in the absence of signaling. Serotonergic ACs may be a central switch in controlling retinal function, though these ACs must also serve GABAergic roles. Non-mammalian serotonergic ACs are directly driven by mixed rod-cone OFF-center BCs, form feedback synapses to BCs and target GCs and ACs with feedforward synapses (Marc et al., 1988). However, no data exist to discriminate GABAergic versus serotonergic signaling at these sites and serotonin may act globally through diffusion. Serotonin reciprocally modulates ON and OFF channels: 5HT3R activation suppresses scotopic mammalian OFF-center GC responses while 5HT3R antagonism inhibits ON-center GC responses, sparing cone-driven responses (Jin and Brunken, 1998). These complex reciprocal effects could act at PRs or BCs and much remains to be resolved.

Serotonin. Future directions. The mammalian serotonin-transporting AC lacks histochemically and immunohistochemically detectable serotonin. Is an undiscovered monoamine involved or are serotonergic synapses and vesicles rare, and serotonin synthesis is restricted to small dendritic volumes? Is TrpH or VMAT2 expressed in mammalian ACs? Does serotonergic signaling involve PR-derived serotonin and are TRP receptors involved?

Other neuroactive molecules.

Many non-peptide species can target ionotropic receptors, GPCRs, tyrosine kinase receptors and intracellular response elements and more will likely be found. These additional signals emanate from multifarious sources and modulate signaling within diverse neuronal, glial and epithelial targets, though none is known to be a primary fast signal.

Nitric oxide (NO) derived from Ca^{2+} -coupled NO synthase arginine-citrulline cycling potentially arises from numerous vertical and lateral channel sources and can target an array of cells through guanylate cyclase activation (Eldred, 2001). The effects are potent and include cGMP modulation of cone synaptic Ca^{2+} channels and HC coupling. The involvement of *carbon monoxide signaling* in retina is only now being explored.

Melatonin signaling, somewhat the inverse of dopamine signaling, initiates with melatonin production in scotophase PRs, diffusion to target melatonin receptors (Wiechmann and Smith, 2001), and activates dark-adapted and suppresses light-adapted states. Melatonin signaling is coupled to intrinsic circadian oscillator pathways in PRs, but such pathways are complex and simple assignment of photic states to melatonin-versus-dopamine signaling is certainly inaccurate.

Retina expresses a variety of **ATP**-activated ionotropic P2X receptors on neurons and MCs (Pannicke et al., 2000; Taschenberger et al., 1999) and P2Y GPCRs are expressed in retina (Deng et al., 1998), though the ATP sources and magnitudes of receptor-gated signaling remain to be resolved.

One of the newest signal candidates in retina is the **cannabinoid** agonist *anandamide* (N-arachidonylethanolamine) or a related molecule that activates cannabinoid CB1 and CB2 GPCRs expressed on retinal neurons (Straiker et al., 1999; Yazulla et al., 1999). Retinal distributions of CNS anandamide transporters and potential interactions with vanilloid receptors are *terra incognita*.

Fin

References

- Akopian, A., R. Gabriel and P. Witkovsky, 1998. Calcium released from intracellular stores inhibits GABAA-mediated currents in ganglion cells of the turtle retina, *J. Neurophysiol.*, 80: 1105-1115.
- Akopian, A. and P. Witkovsky, 1996. D2 dopamine receptor-mediated inhibition of a hyperpolarization-activated current in rod photoreceptors, *J. Neurophysiol.*, 76: 1828-1835.
- Awatramani, G. B. and M. M. Slaughter, 2000. Origin of transient and sustained responses in ganglion cells of the retina, *J. Neurosci.*, 20: 7087-7095.
- Bansal, A., J. H. Singer, B. J. Hwang, W. Xu, A. Beaudet and M. B. Feller, 2000. Mice lacking specific nicotinic acetylcholine receptor subunits exhibit dramatically altered spontaneous activity patterns and reveal a limited role for retinal waves in forming ON and OFF circuits in the inner retina, *J. Neurosci.*, 20: 7672-7681.
- Blanco, R. and P. de la Villa, 1999. Ionotropic glutamate receptors in isolated horizontal cells of the rabbit retina, *Eur. J. Neurosci.*, 11: 867-873.
- Brändstatter, J. H., P. Koulen and H. Wässle, 1997. Selective synaptic distribution of kainate receptor subunits in the two plexiform layers of the rat retina, *J. Neurosci.*, 17: 9298-9307.
- Chaudhry, F. A., R. J. Reimer, D. Krizaj, D. Barber, J. Storm-Mathisen, D. Copenhagen and R. H. Edwards, 1999. Molecular analysis of System N suggests novel physiological roles in nitrogen metabolism and synaptic transmission, *Cell & Tissue Kinetics*, 99: 769-780.
- Cherubini, E. and F. Conti, 2001. Generating diversity at GABAergic synapses, *Trends in Neuroscience*, 24: 155-162.
- Connor, J. X., A. J. Boileau and C. Czajkowski, 1998. A GABA_A receptor α 1 subunit tagged with Green Fluorescent Protein requires a β subunit for functional surface expression, *J. Biol. Chem.*, 273: 28906-28911.
- Cook, P. B., P. D. Lukasiewicz and J. S. McReynolds, 2000. GABA_(C) receptors control adaptive changes in a glycinergic inhibitory pathway in salamander retina, *J. Neurosci.*, 20: 806-182.
- Davies, P. A., M. Pistis, M. C. Hanna, J. A. Peters, J. J. Lambert, T. G. Hales and E. F. Kirkness, 1999. The 5-HT_{3B} subunit is a major determinant of serotonin-receptor function, *Nature*, 397: 359-363.
- Deng, G., C. Matute, C. K. Kumar, D. J. Fogarty and R. Miledi, 1998. Cloning and expression of a P2Y purinoceptor from the adult bovine corpus callosum, *Neurobiology of Disease*, 5: 259-270.
- DeVries, S., 2000. Bipolar cells use kainate and AMPA receptors to filter visual information into separate channels, *Neuron*, 28: 847-856.
- Dhingra, A., A. Lyubarsky, M. Jiang, E. N. J. Pugh, L. Birnbaumer, P. Sterling and N. Vardi, 2000. The light response of ON bipolar neurons requires G α_o , *J. Neurosci.*, 20: 9053-9058.
- Diamond, J. S. and D. R. Copenhagen, 1995. The relationship between light-evoked synaptic excitation and spiking behaviour of salamander retinal ganglion cells, *J. Physiol.*, 487: 711-725.
- Dingledine, R., K. Borges, D. Bowie and S. F. Traynelis, 1999. The Glutamate Receptor Ion Channels, *Pharmacological Reviews*, Vol. 51: 8-61.

- Dmitrieva, N. A., J. M. Lindstrom and K. T. Keyser, 2001. The relationship between GABA-containing cells and the cholinergic circuitry in the rabbit retina, *Visual Neuroscience*, 18: 93-100.
- Eiden, L. E., 2000. The vesicular neurotransmitter transporters: current perspectives and future prospects., *FASEB Journal*, 14: 2396-2400.
- Eldred, W. D., 2001. Real time imaging of the production and movement of nitric oxide in the retina, *Progress in Brain Research*, 131: 109-122.
- Erickson, J. D. and H. Varoqui, 2000. Molecular analysis of vesicular amine transporter function and targeting to secretory organelles, *FASEB Journal*, 14: 2450-2458.
- Famiglietti, E. V., 1991. Synaptic organization of starburst amacrine cells in rabbit retina: analysis of serial thin sections by electron microscopy and graphic reconstruction, *J. Comp. Neurol.*, 309: 40-70.
- Featherstone, D. E., E. M. Rushton, M. Hilderbrand-Chae, A. M. Phillips, F. R. Jackson and K. Broadie, 2000. Presynaptic glutamic acid decarboxylase is required for induction of the postsynaptic receptor field at a glutamatergic synapse, *Neuron*, 27: 71-84.
- Feigenspan, A. and J. Bormann, 1994. Differential contributions of GABA_A and GABA_C receptors on rat retinal bipolar cells, *Proc. Nat. Acad. Sci. USA*, 91: 10893-10897.
- Feigenspan, A., S. Gustinich, B. P. Bean and E. Raviola, 1998. Spontaneous activity of solitary dopaminergic cells of the retina, *J. Neurosci.*, 18: 6776-6789.
- Fischer, A. J., L. A. McKinnon, N. M. Nathanson and W. K. Stell, 1998. Identification and localization of muscarinic acetylcholine receptors in the ocular tissues of the chick, *J. Comp. Neurol.*, 392: 273-284.
- Fletcher, E. L., I. Hack, J. H. Brandstatter and H. Wässle, 2000. Synaptic localization of NMDA receptor subunits in the rat retina, *J. Comp. Neurol.*, 420: 98-112.
- Gaal, L., B. Roska, S. A. Picaud, S. M. Wu, R. E. Marc and F. S. Werblin, 1998. Postsynaptic response kinetics are controlled by a glutamate transporter at cone photoreceptors., *J. Neurophysiol.*, 79: 190-196.
- Ghosh, K. K., S. Haverkamp and H. Wässle, 2001. Glutamate receptors in the rod pathway of the mammalian retina, *J. Neurosci.*, 21: 8636-8647.
- Grant, G. B. and J. E. Dowling, 1996. On bipolar cell responses in the teleost retina are generated by two distinct mechanisms, *J. Neurophysiol.*, 76: 3842-3949.
- Greferath, U., U. Grünert, F. Müller and H. Wässle, 1994. Localization of GABA_A receptors in the rabbit retina, *Cell and Tissue Research*, 276: 295-307.
- Hampson, E. C., D. I. Vaney and R. Weiler, 1992. Dopaminergic modulation of gap junction permeability between amacrine cells in mammalian retina, *J. Neurosci.*, 12: 4911-4922.
- Haverkamp, S., U. Grunert and H. Wässle, 2001. The synaptic architecture of AMPA receptors at the cone pedicle of the primate retina, *J. Neurosci.*, 21: 2488-2500.
- Haverkamp, S., U. Grünert and H. Wässle, 2000. The cone pedicle, a complex synapse in the retina, *Neuron*, 27: 85-95.

- He, S. and R. H. Masland, 1997. Retinal direction selectivity after targeted laser ablation of starburst amacrine cells, *Nature*, 389: 378-382.
- Jin, X. T. and W. J. Brunken, 1998. Serotonin receptors modulate rod signals: a neuropharmacological comparison of light- and dark-adapted retinas, *Visual Neuroscience*, 15: 891-902.
- Johnson, J., T. K. Chen, D. W. Rickman, C. Evans and N. C. Brecha, 1996. Multiple γ -aminobutyric acid plasma membrane transporters (GAT-1, GAT-2, GAT-3) in the rat retina, *J. Comp. Neurol.*, 375: 212-224.
- Johnson, M. A. and N. Vardi, 1998. Regional differences in GABA and GAD immunoreactivity in rabbit horizontal cells, *Visual Neuroscience*, 15: 743-753.
- Jones, K. A., B. Borowsky, J. A. Tamm, D. A. Craig, M. M. Durkin, M. Dai, W. J. Yao, M. Johnson, C. Gunwaldsen, L. Y. Huang, C. Tang, Q. Shen, J. A. Salon, K. Morse, T. Laz, K. E. Smith, D. Nagarathnam, S. A. Noble, T. A. Branchek and C. Gerald, 1998. GABA_(B) receptors function as a heteromeric assembly of the subunits GABA_(B)R1 and GABA_(B)R2, *Nature*, 396: 674-679.
- Kalloniatis, M. and G. Tomisich, 1999. Amino acid neurochemistry of the vertebrate retina, *Progress in Retinal & Eye Research*, 18: 811-866.
- Kamermans, M., I. Fahrenfort, K. Schultz, U. Janssen-Bienhold, T. Sjoerdsma and R. Weiler, 2001. Hemichannel-mediated inhibition in the outer retina, *Science*, 292: 1178-1180.
- Keyser, K. T., M. A. MacNeil, N. Dmitrieva, F. Wang, R. H. Masland and J. M. Lindstrom, 2000. Amacrine, ganglion, and displaced amacrine cells in the rabbit retina express nicotinic acetylcholine receptors, *Visual Neuroscience*, 17: 743-752.
- Kittila, C. A. and S. C. Massey, 1997. Pharmacology of directionally selective ganglion cells in the rabbit retina, *J. Neurophysiol.*, 77: 675-689.
- Koulen, P., 1997. Vesicular acetylcholine transporter (VACHT): a cellular marker in rat retinal development, *Neuroreport*, 8: 2845-2848.
- Koulen, P., J. H. Brandstatter, S. Kroger, R. Enz, J. Bormann and H. Wassle, 1997a. Immunocytochemical localization of the GABA_(C) receptor rho subunits in the cat, goldfish, and chicken retina, *J. Comp. Neurol.*, 380: 520-532.
- Koulen, P., R. Kuhn, H. Wassle and J. H. Brandstatter, 1997b. Group I metabotropic glutamate receptors mGluR1 α and mGluR5a: localization in both synaptic layers of the rat retina, *J. Neurosci.*, 17: 2200-2211.
- Koulen, P., B. Malitschek, R. Kuhn, B. Bettler, H. Wassle and J. H. Brandstatter, 1998. Presynaptic and postsynaptic localization of GABA_(B) receptors in neurons of the rat retina, *Eur. J. Neurosci.*, 10: 1446-1456.
- Koulen, P., B. Malitschek, R. Kuhn, H. Wassle and J. H. Brandstatter, 1996. Group II and group III metabotropic glutamate receptors in the rat retina: distributions and developmental expression patterns, *Eur. J. Neurosci.*, 8: 2177-2187.
- Linberg, K. A. and S. K. Fisher, 1988. Ultrastructural evidence that horizontal cell axon terminals are presynaptic in the human retina, *J. Comp. Neurol.*, 268: 281-297.
- Lukasiewicz, P. D. and C. R. Shields, 1998. Different combinations of GABA_A and GABA_C receptors confer distinct temporal properties to retinal synaptic responses., *J. Neurophysiol.*, 79: 3157-3167.

- Marc, R. E., 1992. Structural organization of GABAergic circuitry in ectotherm retinas, *Progress in Brain Research*, 90: 61-92.
- Marc, R. E., 1995. Interplexiform cell connectivity in the outer retina, *In Neurobiology of the Vertebrate Outer Retina*, (S. Archer, M. B. Djamgoz and S. Vallergera, eds). London: Chapman and Hall, 369-393.
- Marc, R. E., 1999. Mapping glutamatergic drive in the vertebrate retina with a channel-permeant organic cation, *J. Comp. Neurol.*, 407: 47-64.
- Marc, R. E. and B. W. Jones, 2002. Molecular phenotyping of retinal ganglion cells, *J. Neurosci.*, 22: 413-427.
- Marc, R. E. and W. Liu, 2000. Fundamental GABAergic amacrine cell circuitries in the retina: nested feedback, concatenated inhibition, and axosomatic synapses, *J. Comp. Neurol.*, 425: 560-582.
- Marc, R. E., W. L. Liu, K. Scholz and J. F. Muller, 1988. Serotonergic and serotonin-accumulating neurons in the goldfish retina, *J. Neurosci.*, 8: 3427-3450.
- Masu, M., H. Iwakabe, Y. Tagawa, T. Miyoshi, M. Yamashita, Y. Fukuda, H. Sasaki, K. Hiroi, Y. Nakamura and R. Shigemoto, 1995. Specific deficit on the ON response in visual transmission by targeted disruption of the mGluR6 gene, *Cell*, 80: 757-765.
- Matthews, G., G. S. Ayoub and R. Heidelberger, 1994. Presynaptic inhibition by GABA is mediated via two distinct GABA receptors with novel pharmacology, *J. Neurosci.*, 14: 1079-1090.
- McIntire, S. L., R. J. Reimer, K. Schuske, R. H. Edwards and E. M. Jorgensen, 1997. Identification and characterization of the vesicular GABA transporter., *Nature*, 389: 870-876.
- Morigiwa, K. and N. Vardi, 1999. Differential expression of ionotropic glutamate receptor subunits in the outer retina, *J. Comp. Neurol.*, 405: 173-184.
- O'Malley, D. M., J. H. Sandell and R. H. Masland, 1992. Co-release of acetylcholine and GABA by the starburst amacrine cells, *J. Neurosci.*, 12: 1394-1408.
- Pannicke, T., W. Fischer, B. Biedermann, H. Schadlich, J. Grosche, F. Faude, P. Wiedemann, C. Allgaier, P. Illes, G. Burnstock and A. Reichenbach, 2000. P2X7 receptors in Muller glial cells from the human retina, *J. Neurosci.*, 20: 5965-5972.
- Picaud, S., B. Pattnaik, D. Hicks, V. Forster, V. Fontaine, S. Sahel and H. Dreyfus, 1998. GABA_A and GABA_C receptors in adult porcine cones: evidence from a photoreceptor—glia co-culture model, *J. Physiol.*, 513: 33-42.
- Pootanakit, K. and W. J. Brunken, 2001. Identification of 5-HT(3A) and 5-HT(3B) receptor subunits in mammalian retinae: potential pre-synaptic modulators of photoreceptors, *Brain Research*, 896: 77-85.
- Pootanakit, K., K. J. Prior, D. D. Hunter and W. J. Brunken, 1999. 5-HT_{2a} receptors in the rabbit retina: potential presynaptic modulators, *Visual Neuroscience*, 16: 221-230.
- Pow, D. V., 1998. Transport is the primary determinant of glycine content in retinal neurons, *J. Neurochem.*, 70: 2628-2636.
- Pow, D. V., N. L. Barnett and P. Penfold, 2000. Are neuronal transporters relevant in retinal glutamate homeostasis?, *Neurochemistry International*, 37: 191-198.

- Rieke, F. and E. A. Schwartz, 1994. A cGMP-gated current can control exocytosis at cone synapses, *Neuron*, 13: 863-873.
- Schwartz, E. A., 1999. A transporter mediates the release of GABA from horizontal cells, *In The Retinal Basis of Vision*, (J.-I. Toyoda, M. Murkami, A. Kaneko and T. Saito, eds). Amsterdam: Elsevier, 93-101.
- Seal, R. P. and S. G. Amara, 1999. Excitatory amino acid transporters: A family in flux, *Ann. Rev. Pharm. Tox.*, 39: 431-456.
- Stobrawa, S. M., T. Breiderhoff, S. Takamori, D. Engel, M. Schweizer, A. A. Zdebik, M. R. Bösl, K. Ruether, H. Jahn, A. Draguhn, R. Jahn and T. J. Jentsch, 2001. Disruption of CIC-3, a chloride channel expressed on synaptic vesicles, leads to a loss of the hippocampus, *Neuron*, 29: 185-196.
- Straiker, A., N. Stella, D. Piomelli, K. Mackie, H. J. Karten and G. Maguire, 1999. Cannabinoid CB1 receptors and ligands in vertebrate retina: localization and function of an endogenous signaling system, *Proc. Nat. Acad. Sci. USA*, 96: 14565-14570.
- Sullivan, R., A. Chateaufneuf, N. Coulombe, L. F. Kolakowski, Jr., M. P. Johnson, T. E. Hebert, N. Ethier, M. Belley, K. Metters, M. Abramovitz, G. P. O'Neill and G. Y. Ng, 2000. Coexpression of full-length GABA_(B) receptors with truncated receptors and metabotropic glutamate receptor 4 supports the GABA_(B) heterodimer as the functional receptor, *J. Pharm. Exp. Therap.*, 293: 460-467.
- Takamori, S., J. Rhee, C. Rosenmund and R. Jahn, 2000. Identification of a vesicular glutamate transporter that defines a glutamatergic phenotype in neurons., *Nature*, 407: 189-194.
- Taschenberger, H., R. Jüttner and R. Grantyn, 1999. Ca²⁺-permeable P2X receptor channels in cultured rat retinal ganglion cells, *J. Neurosci.*, 19: 3353-3366.
- Vandenbranden, C. A., J. Verweij, M. Kamermans, L. J. Muller, J. M. Ruijter, G. F. Vrensen and H. Spekrijse, 1996. Clearance of neurotransmitter from the cone synaptic cleft in goldfish retina, *Vision Research*, 36: 3859-3874.
- Vaquero, C. F., A. Pignatelli, G. J. Partida and A. T. Ishida, 2001. A dopamine- and protein kinase A-dependent mechanism for network adaptation in retinal ganglion cells, *J. Neurosci.*, 21: 8624-8635.
- Vardi, N., R. Duvoisin, G. Wu and P. Sterling, 2000a. Localization of mGluR6 to dendrites of ON bipolar cells in primate retina, *J. Comp. Neurol.*, 423: 402-412.
- Vardi, N., L.-L. Zhang, J. A. Payne and P. Sterling, 2000b. Evidence that different cation chloride cotransporters in retinal neurons allow opposite responses to GABA, *J. Neurosci.*, 20: 7657-7663.
- Varoqui, H., M. K.-H. Schafer, H. Zhu, E. Weihe and J. D. Erickson, 2002. Identification of the differentiation-associated Na⁺/PI Transporter as a novel vesicular glutamate transporter expressed in a distinct set of glutamatergic synapses, *J. Neurosci.*, 22: 142-155.
- Varoqui, H., H. Zhu, D. Yao, H. Ming and J. D. Erickson, 2000. Cloning and functional identification of a neuronal glutamine transporter, *J. Biol. Chem.*, 275: 4049-4054.
- Wässle, H., P. Koulen, J. H. Brändstätter, E. L. Fletcher and C. M. Becker, 1998. Glycine and GABA receptors in the mammalian retina, *Vision Research*, 38: 1411-1430.

- Wiechmann, A. F. and A. R. Smith, 2001. Melatonin receptor RNA is expressed in photoreceptors and displays a diurnal rhythm in *Xenopus* retina, *Brain Research. Molecular Brain Research*, 91: 104-111.
- Witkovsky, P. and A. Dearry, 1991. Functional roles of dopamine in the vertebrate retina., *Progress in Retinal Research*, 11: 247-292.
- Witkovsky, P., C. Nicholson, M. E. Rice, K. Bohmaker and E. Meller, 1993. Extracellular dopamine concentration in the retina of the clawed frog, *Xenopus laevis*, *Proc. Nat. Acad. Sci. USA*, 90: 5667-56671.
- Wu, S. M., 1994. Synaptic transmission in the outer retina, *Ann. Rev. Physiol.*, 56: 141-168.
- Yazulla, S., 1995. Neurotransmitter release from horizontal cells, *In Neurobiology and Clinical Aspects of the Outer Retina*, (S. Archer, M. B. Djamgoz and S. Vallergera, eds). London: Chapman and Hall, 249-271.
- Yazulla, S., K. M. Studholme, H. H. McIntosh and D. G. Deutsch, 1999. Immunocytochemical localization of cannabinoid CB1 receptor and fatty acid amide hydrolase in rat retina, *J. Comp. Neurol.*, 415: 80-90.
- Zhang, C., B. Bettler and R. Duvoisin, 1998a. Differential localization of GABA_(B) receptors in the mouse retina, *Neuroreport*, 9: 3493-3497.
- Zhang, D., N. J. Sucher and S. A. Lipton, 1995. Co-expression of AMPA/kainate receptor-operated channels with high and low Ca²⁺ permeability in single rat retinal ganglion cells, *Neuroscience*, 67: 177-88.
- Zhang, J., C. S. Jung and M. M. Slaughter, 1997a. Serial inhibitory synapses in retina, *Visual Neuroscience*, 14: 553-63.
- Zhang, J., W. Shen and M. M. Slaughter, 1997b. Two metabotropic γ -aminobutyric acid receptors differentially modulate calcium currents in retinal ganglion cells, *J. Gen. Physiol.*, 110: 45-58.
- Zhang, J., N. Tian and M. M. Slaughter, 1998b. Neuronal discriminator formed by metabotropic γ -aminobutyric acid receptors, *J. Neurophysiol.*, 80: 3365-3378.

Table 1: L-glutamate (2S)-2-Aminopentanedioic acid
MW:147.13
Zwitterion at pH 6-8

Localization:
rods & cones (≈ 1 mM)
BCs, GCs (5-10 mM)
ACs (0.04-1 mM)
MCs (0.04-0.3 mM)

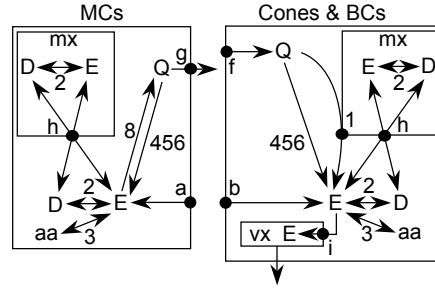
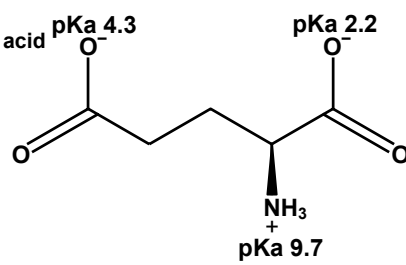

Metabolism: enzyme	EC	map	site	major reactants	→	products
1 glutaminase	3.5.1.2	G7	mim	Q	→	E
2 aspartate transaminase	2.6.1.1	F4-5	mx c	D + 2-oxoglutarate	↔	E + oxaloacetate
3 multiple transaminases	2.6.1.x		mx c	aa + 2-oxoglutarate	↔	E + 2-oxo acid
4 GMP synthase	6.3.4.1	G1	c	Q + xanthosine	→	E + 5' GMP
5 CTP synthase	6.3.4.2	J7	c	Q + UTP	→	E + CTP
6 glutamine-F6P transaminase	2.6.1.16	D4	c	Q + F6P	→	E + glucosamine-6-P
7 glutamate dehydrogenase	1.4.1.2	H6-7G7	mx	E	↔	2-oxoglutarate
8 glutamate-ammonia ligase	6.3.1.2	G7 H7	c	E	→	Q
9 glutamate-cysteine ligase	6.3.2.2	H7	c	E + C	→	γ glutamylcysteine

Transporters	TC	Localization
plasma membrane		
a EAAT1 (GLAST)	2.A.23.2.1	∇ Φ MCs
b EAAT2 (GLT1)	2.A.23.2.2	∇ Φ PRs, ∇ cBCs
c EAAT3 (EEAC1)	2.A.23.2.3	∇ ACs
d EAAT4	2.A.23.2.n	∇ not in retina
e EAAT5	2.A.23.2.n	∇ rods
f Glnt (Q import)	2.A.18.6.1	∇ neurons

Transporters	TC	Localization
plasma membrane		
g SN1 (Q export)	2.A.18.6.3	∇ glia
mitochondria		
h D/E antiporter	2.A.29.14.1.2	Φ mim
synaptic vesicles		
i VGluT1, 2	2.A.1.14.13	∇ brain vm

Receptors: Ionotropic	TC	Subtypes	Localization
KA	1.A.10.1.1	KA12, GluR567	∇Φ: OFF cBCs (KA2); ∇: HCs (GluR6,7)
AMPA	1.A.10.1.2	GluR1234	∇Φ: HCs, OFF cBCs, ACs, GCs
Orphan δ	1.A.10.1.n	δ1,2	∇: A17 ACs, other ACs, GCs
NMDA	1.A.10.1.3	NR1abcd, NR2bc	∇Φ: ACs, GCs ∇: rod BCs (NR2b) ∇: cones (NR2C)

Receptors: Heptahelical	Subtypes	Localization
GPCR Class C mGluR Group I Gs	mGluR1,5	∇: ACs, rod BCs (mGluR1α), cBCs (mGluR5a)
GPCR Class C mGluR Group II Gi	mGluR2	Φ: PRs ∇: starburst ACs other ACs
GPCR Class C mGluR Group III Gi	mGluR4,7,8	∇: inner retina (4,7,8)
	mGluR6	∇Φ: ON BCs

Abbreviations			
aa: amino acid	cBCs: cone BCs	pm: plasma membrane	∇: anatomical localization
c: cytosol	F6P: fructose-6-P	px: peroxisome	Φ: physiological localization
ca: carboxylic acid	mim: mitochondrial inner membrane	vm: vesicular membrane	
	mx: mitochondria matrix	vx: vesicle matrix	

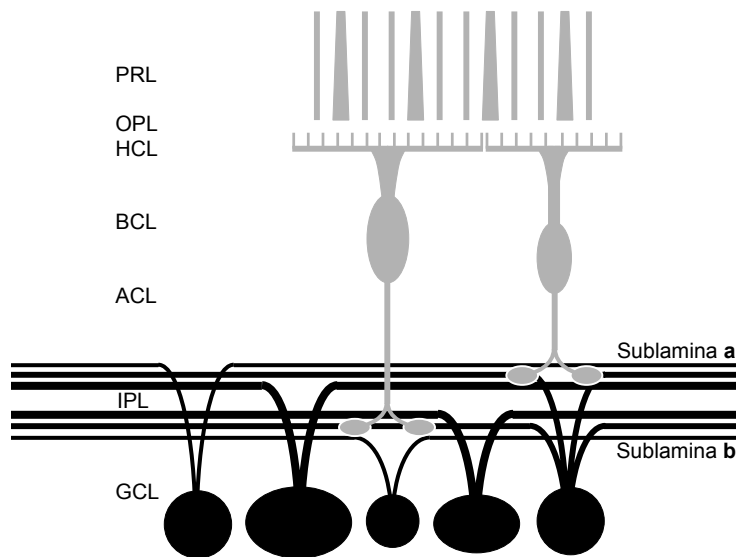

Neurons expressing glutamatergic phenotypes include all of the cells using ribbon synapses for signaling: rods, cones, and all BCs (grey). All GCs also display a glutamatergic phenotype but with a different metabolic signature.

PRL photoreceptor layer
 OPL outer plexiform layer
 HCL horizontal cell layer
 BCL bipolar cell layer
 ACL amacrine cell layer
 IPL inner plexiform layer
 GCL ganglion cell layer

All **Metabolism map** loci index the Boehringer Mannheim Biochemical Pathway diagram accessed through www.expasy.org and its mirrors

Table 2: γ -aminobutyric acid

4-Aminobutanoic acid
MW:103.12
Zwitterion at pH 7

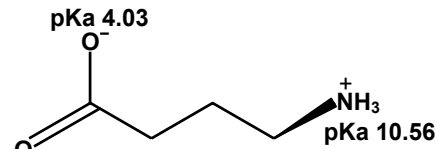

Localization:
HC subsets (0.5-2 mM)
 γ^+ AC subsets (1-10 mM)
 γ^- AC subsets (0.04-0.5 mM, possible AC \rightarrow AC coupling leaks)
GC subsets (0.04-0.5 mM, AC \rightarrow GC coupling leaks)
MCs (0.08-0.5 mM \rightarrow rises in anoxia)

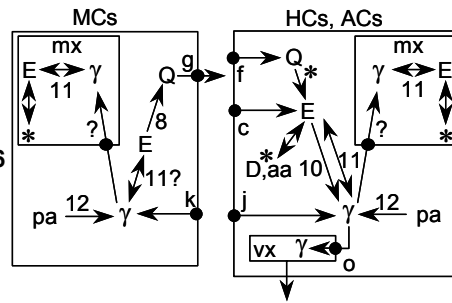

Metabolism: enzyme	EC	map	site	reactants	products
10 4-aminobutyrate decarboxylase	4.1.1.15	H6	m c	E	γ
11 4-aminobutyrate transaminase	2.6.1.19	H6	mx	γ + 2-oxoglutarate	E + SSA
12 aminobutyraldehyde dehydrogenase	1.2.1.19	F6 F7 H6	c	4-aminobutanal	γ

Transporters

plasma membrane	TC	Localization
j GAT1	2.A.22.3.2	∇ ACs
k GAT3	2.A.22.3.2	$\nabla\Phi$ MCs
l GAT2	2.A.22.3.1	∇ RPE
m betaine	2.A.22.3.1	?
mitochondria		
n unidentified γ porter		mim
synaptic vesicles		
o VGAT	2.A.1.14.13	$\nabla\Phi$ brain vm

Receptors: Ionotropic

Subtypes	Dominant Localization
GABA _A	$\nabla\Phi$ cones, BCs, ACs, GCs Φ HCs
GABA _C	$\nabla\Phi$ cones, BCs Φ HCs

Receptors: Heptahelical

Subtypes	Dominant Localization
GPCR Class C GABA _B	Φ BCs (Ca channel), GCs (gK); ∇ HCs, ACs

Abbreviations: see Table 1 pa: polyamines *: links to Table 1 SSA: succinate semialdehyde γ : GABA

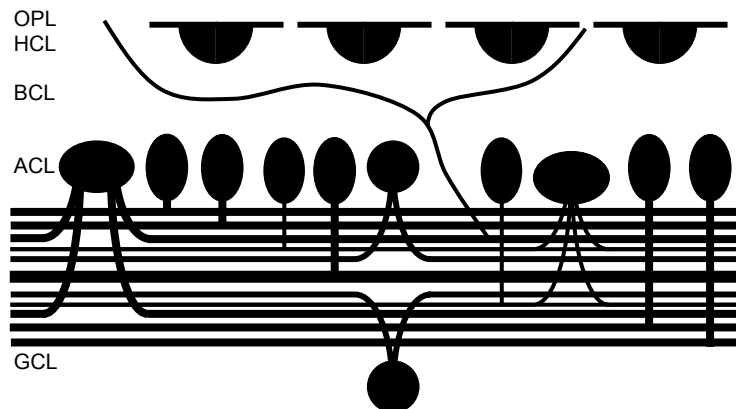

Neurons expressing GABAergic phenotypes are lateral interneurons, including a subset of or all HCs, depending on species, and most ACs, including displaced starburst ACs. GABA signals fill the inner plexiform layer with no interruption due to overlapping AC arborizations. Some GABAergic ACs are also IPCs, though their specific connectivities are unknown.

Table 3: Glycine

Aminoethanoic acid
 MW:75.02
 Zwitterion at pH 7

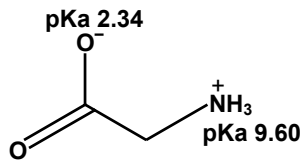

Localization:
 G+ ACs (≈ 1-5 mM)
 G- ACs (0.1-0.3 mM)
 ON BCs (≈ 0.5-1 mM, AC → BC coupling leak in mammals)
 class 7 GCs (≈ 0.5 mM, AC → GC coupling leak)
 all other cells <0.3 mM

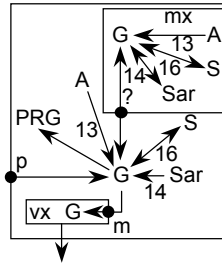

Metabolism: enzyme	EC	map	site	reactants	→ products
13 alanine-glyoxylate transaminase	2.6.1.44	B7	px mx	A + glyoxalate	→ G + pyruvate
14 glycine N-methyltransferase	2.1.1.20	...	c	SAH + S	↔ G+ SAM
15 sarcosine dehydrogenase	1.5.99.1	B7	mx	Sar + acc	→ G + H ₂ C=O + acc-H
16 glycine hydroxymethyltransferase	2.1.2.1	B6	c mx	TH4 + S	↔ 5,10-CH ₂ TH4 + G
17 PRamine-glycine ligase	6.3.4.13	D2	c	PRamine + G	→ PRG

Transporters

plasma membrane	TC	Localization
p GlyT1	2.A.22.2.2	∇ ACs
q GlyT2	2.A.22.2.2	not in retina
r Low affinity	n.n.n.n.n	?
mitochondria		
s unidentified G porter		mim
synaptic vesicles		
t VIAAT	2.A.1.14.n	Φ brain vm

Receptors: Ionotropic

GlyR	TC	Subtypes	Dominant Localization
	1.A.9.3.1	α1, α2, α2*, α3, β	∇Φ BCs, ACs, GCs Φ HCs

Abbreviations: see Tables 1,2
 PR: 5-P-D-ribosyl-

PRG: PR-glycinamide
 px: peroxisome matrix

SAH: S-adenosyl-L-homocysteine
 SAM: S-adenosyl-L-methionine

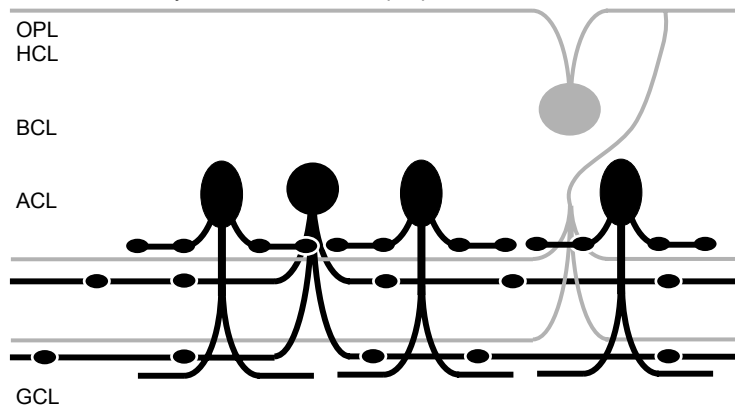

Neurons expressing the glycinergic phenotype (high-affinity glycine transporter) in all species are ACs of several narrow-field and diffuse types, with sparse arbors forming broad distal and proximal bands in the inner plexiform layer. The circuitries of some mammalian glycinergic ACs differ markedly from non-mammalians yet are similar in shape. Many non-mammalians also have a glycinergic IPC (grey) that receives input from GABAergic HCs and targets many neuronal types in the inner plexiform layer.

Table 4: Acetylcholine

2-(acetyloxy)-N,N,N-trimethylethanaminium⁺
 MW: 147
 Cation at physiological pH

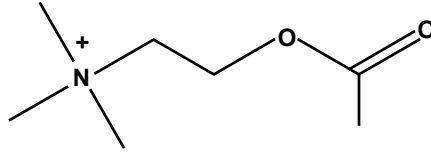

Localization:
 ACs (enzyme immunocytochemistry)

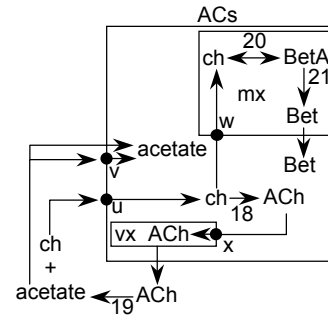

Metabolism: enzyme	EC	map	site
18 cholineacetyl transferase	2.3.1.6	B8	c pm
19 acetylcholinesterase	3.1.1.7	B8	c pm ecm
20 choline dehydrogenase	1.1.99.1	B8	mim
21 BetA dehydrogenase	1.2.1.8	B8	mx

reactants	→	products
acetyl-CoA + ch	→	CoA + ACh
ACh	→	ch + acetate
ch	↔	BetA
BetA	→	Bet

Transporters	TC	Localization
plasma membrane		
u CHT1	2.A.21.8.1	Φ ACs, PRs
v MCT1	2.A.1.13.1	?
mitochondria		
w ch transporter	na	mim
synaptic vesicles		
x VACHT	2.A.1.2.13	Φ brain vm

Receptors: Ionotropic	TC	Subunits	Dominant Localization
nAChR	1.A.9.1.1	α2-10, β2-4	∇Φ ACs, GCs
Receptors: Heptahelical		Subtypes	Dominant Localization
GPCR Class A mAChR Gs		M1,M3,M5	∇ BCs, ACs (M3)
GPCR Class A mAChR Gi/o		M2,4	∇ ACs, GCs

Abbreviations: see Tables 1-3

Bet: betaine
 BetA: betaine aldehyde

ch: choline
 ecm: extracellular matrix

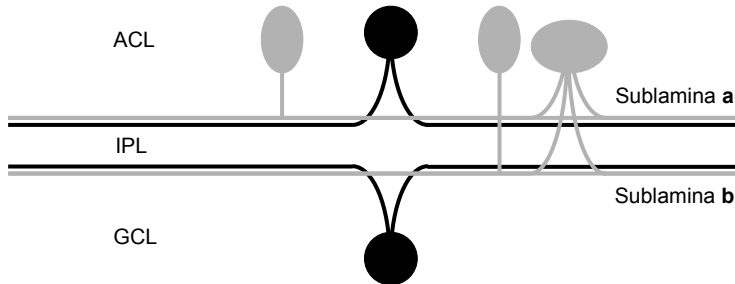

Neurons expressing the cholinergic phenotype include conventional and displaced starburst ACs in all species and, in many non-mammals, additional conventional pyriform ON, pyriform OFF, and bistratified ACs (grey) that also arborize in the two cholinergic strata.

Table 5: Dopamine

3,4 dihydroxyphenethylamine
MW: 153.18
cation at neutral pH

Localization:
ACs, IPCs

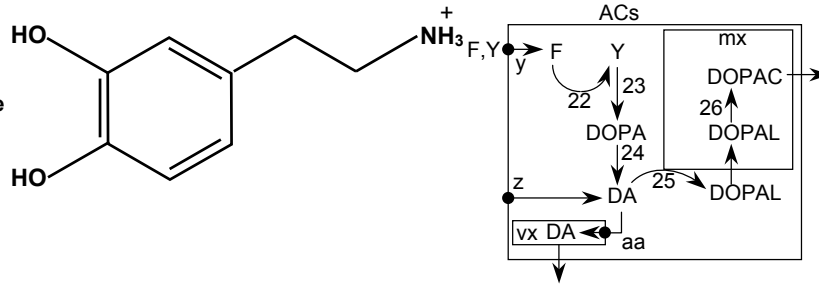

Metabolism: enzyme	EC	map	site	reactants	→	products
22 phenylalanine 4-monooxygenase	1.14.16.1	F3	c	F + BH4	→	Y + BH2
23 tyrosine 3-monooxygenase	1.14.16.2	G2	c	Y + BH4	→	DOPA + BH2
24 aromatic L-aa decarboxylase	4.1.1.28	G2	c	DOPA	→	DA
25 amine oxidase (flavin containing)	1.4.3.4	G2	mom	DA	→	DOPAL
26 aldehyde dehydrogenase (DHA5)	1.2.1.3	G2	mx	DOPAL	→	DOPAC

Transporters

plasma membrane	TC	Localization	synaptic vesicles	TC	Localization
y TAT1 Na ⁺ -coupled	2.A.1.13.2	?	aa VMAT2	2.A.1.22.1	Φ brain vm
z DAT Na ⁺ -coupled	2.A.22.1.3	Φ ACs, IPCs			

Receptors: Heptahelical

GPCR Class A DAR Gs	Subtypes	Dominant Localization
GPCR Class A DAR Gi/o	D1,D5	∇ PRs, ACs Φ HCs, BCs, ACs, GCs
	D2,3,4	∇ PRs (D4) ACs (D2) Φ PRs, HCs

Abbreviations: see Tables 1-4

BH2: dihydrobiopterin DA: dopamine DOPAL: dihydroxyphenylacetaldehyde
 BH4: tetrahydrobiopterin DOPA: dihydroxyphenylalanine
 DOPAC: dihydroxyphenylacetate

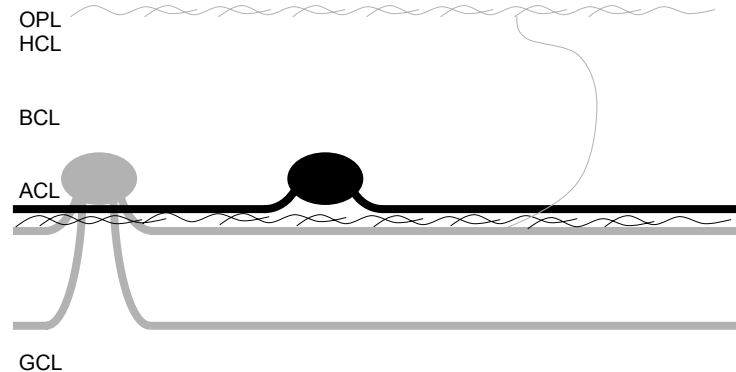

Neurons expressing a dopaminergic phenotype are conventional ACs in most species (black) and arborize in the distal inner plexiform layer with dendritic (heavy lines) and dense axonal fields (fine mesh). Many species exhibit very sparse IPC-like processes targeting the outer plexiform layer. Advanced fishes (teleosts) possess a dopaminergic IPC (grey) with a unique, dense axonal field in the outer plexiform layer and multistratified inner plexiform layer arborizations.

Table 6:
Serotonin
5-hydroxytryptamine
MW: 176.21
Cation at physiological pH

Localization:
ACs in non-mammalians
PRs (biochemistry)

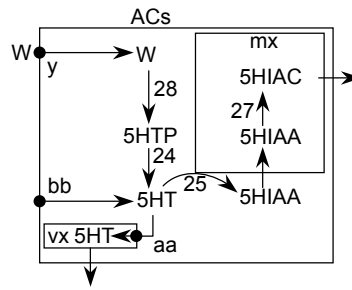
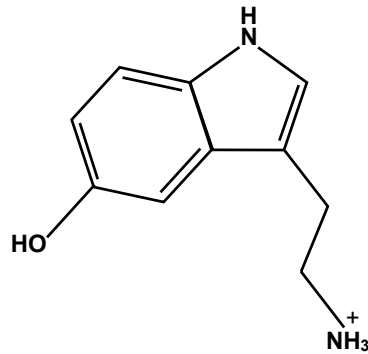

Metabolism: enzyme	EC	map	site	reactants	→	products
28 tryptophan hydroxylase	1.14.16.4	H2 H3	c	W + BH4	→	5HTP + BH2
24 aromatic L-aa decarboxylase	4.1.1.28	H2 I2	c	5HTP	→	5HT
25 amine oxidase (flavin containing)	1.4.3.4	I2	mom	5HT	→	5HIAA
27 aldehyde dehydrogenase (DHA5)	1.2.1.3	I2J2	mx	5HIAA	→	5HIAC

Transporters

plasma membrane	TC	Localization	synaptic vesicles	TC	Localization
y TAT1 Na ⁻ -coupled	2.A.1.13.2	?	aa VMAT2	2.A.1.22.1	Φ brain vm
bb SERT Na ⁺ -coupled	2.A.22.1.1	Φ ACs, IPCs			

Receptors: Ionotropic	TC	Subtypes	Dominant Localization
5HT3	1.A.9.2.1		Φ inner retina

Receptors: Heptaheical	Subtypes	Dominant Localization
GPCR Class A 5HTR Gi/o	5HT1A,B,D,E,F	
GPCR Class A 5HTR Gq	Gq 5HT2A,B,C	
GPCR Class A 5HTR Gs	Gs 5HT4,5,6,7	

Abbreviations: see Table 1

5HIAA: 5-hydroxyindole acetaldehyde
 5HIAAC: 5-hydroxyindole acetate

5HT: 5-hydroxytryptamine, serotonin
 5HTP: 5-hydroxytryptophan

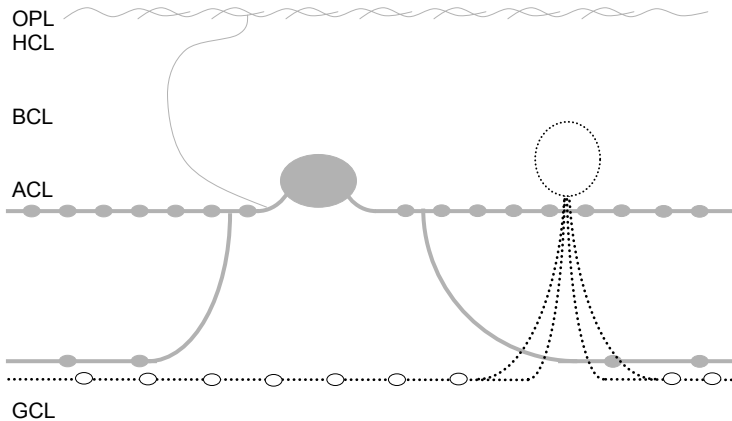

Only non-mammalians express a complete serotonergic phenotype in ACs (grey) with heavily varicose dendrites arborizing heavily in distal and sparsely in proximal strata of the inner plexiform layer. Many of these cells possess fine, sparse axons targeting the outer plexiform layer. Mammalian A17 (S1,2) ACs (dotted) lack a complete phenotype, expressing only SERT-like transport. In all species, ACs with serotonin transport are GABAergic.